















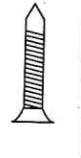

PC0110-PR-81

TABLE LEG ①			corner crimping ⑤		
PART#	DESCRIPTION	QTY	PART#	DESCRIPTION	QTY
	3/8X38 mmBOLT	12		3/8X35 mmBOLT	12
	3/8X76 mmBOLT	16			
	3/8mmX77.7 NUT	16		3/8mmX30mmX3MM WASHER	12
	3/8mmX30mmX3MM WASHER	44		6X16 mmBOLT	16
LEG CONNETTION ②			LONG&SHORT FRAME ⑥		
	3/8X63 mmBOLT	8		3/8X114 mmBOLT	4
	3/8mmX30mmX3MM WASHER	8		3/8mmX30mmX3MM WASHER	4
TOP RAIL ③			SLATE SCREW ⑦		
	3/8X63.5 mmBOLT	18		8#*2"FA PLAT HEAD PHILLIPS SCREW	16
	3/8X24mmX3mm WASHER	18		Semi-tubular rivet 17*34*3/8	4
APRON ④					
	3/8X57 mm" BOLT	12		6*70FA FLAT HEAD PHILLIPS SCREW	16
	3/8mmX30mmX3MM WASHER	12		1000mmX450mmX80mm WOOD	16

Tables in this pool accessory is as follows

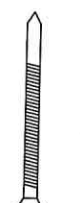

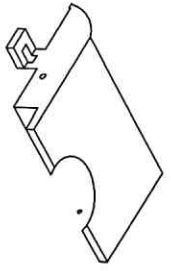
A-MIDDLE HOLEX2

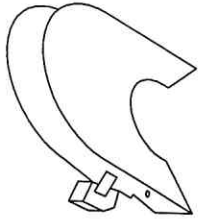

B-CORNERX4

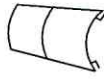

C-NURSING COVERX4

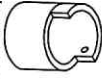

E-drop pocketX6

drop pocket install corner

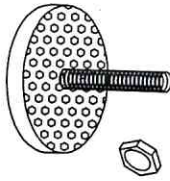

D-TABLE LGEX4

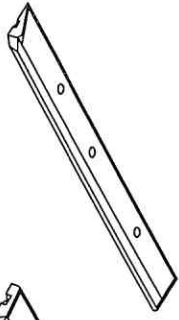

RIGHT TOP RAILX2

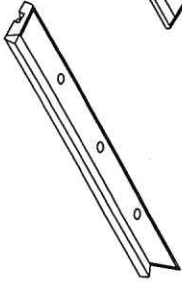

LEFT TOP RAILX2

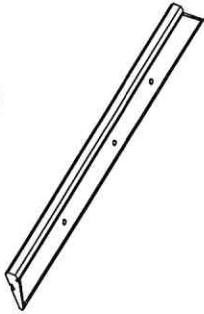

END TOP RAILX2

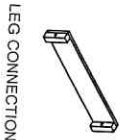

LEG CONNECTIONX2:SHORT

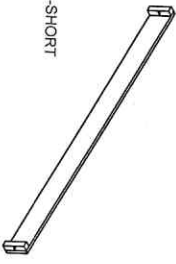

LEG CONNECTIONX2:LONG

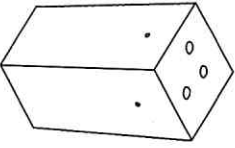
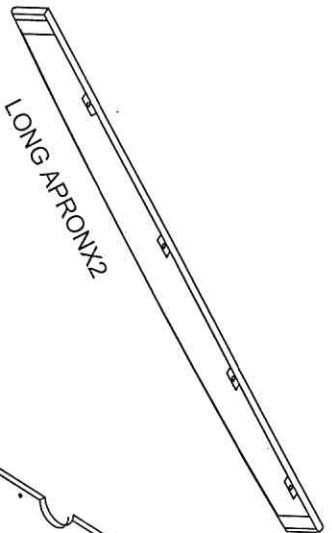
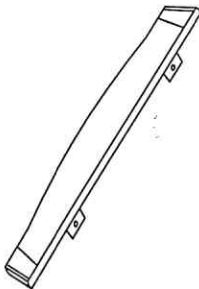

TABLE LEGX4



LONG APRONX2



SHORT APRONX2

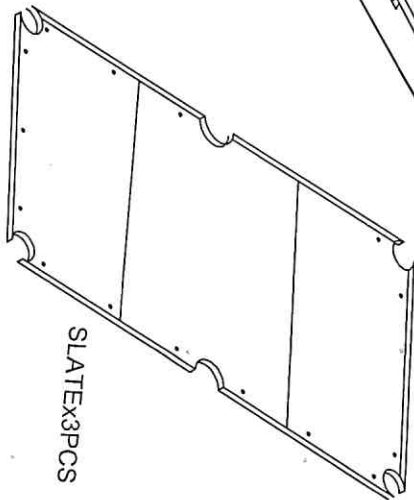

SLATEX3PCS

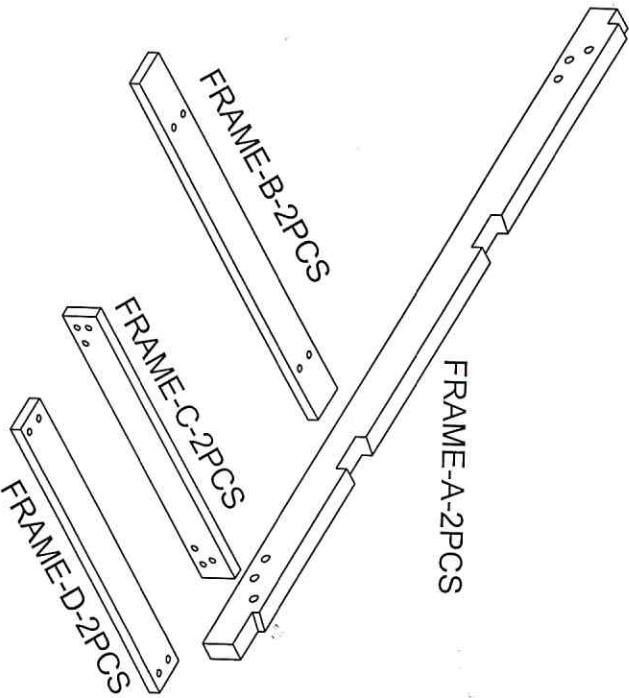

FRAME-A-2PCS

FRAME-B-2PCS

FRAME-C-2PCS

FRAME-D-2PCS

STEP 1

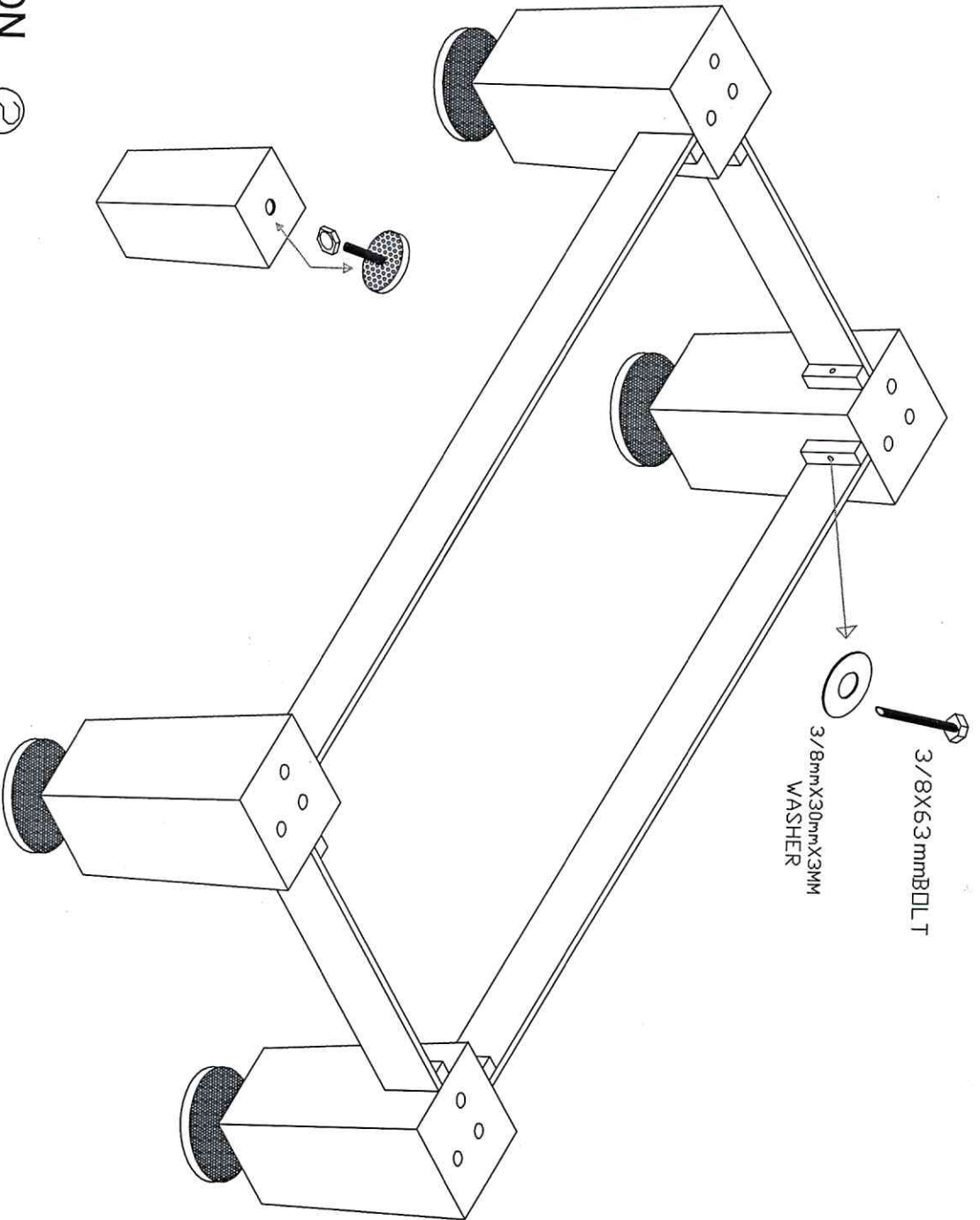

3/8X63mmBOLT

8



3/8mmX30mmX3MM
WASHER

8

STEP 2

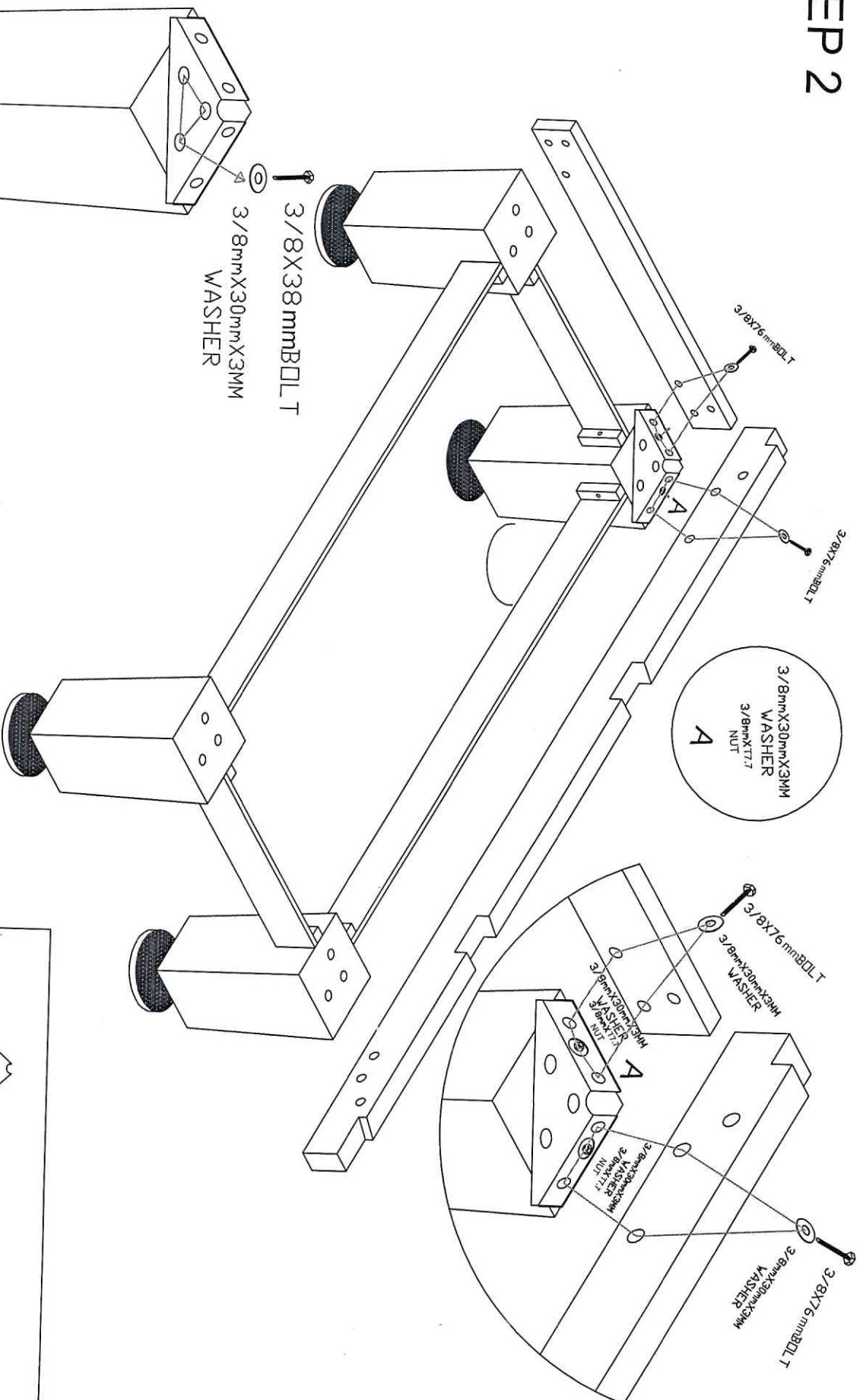
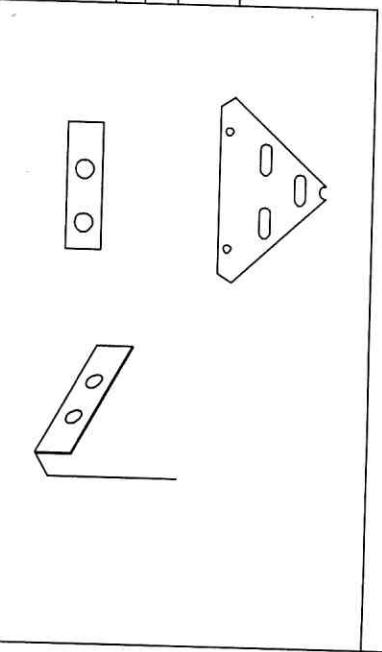
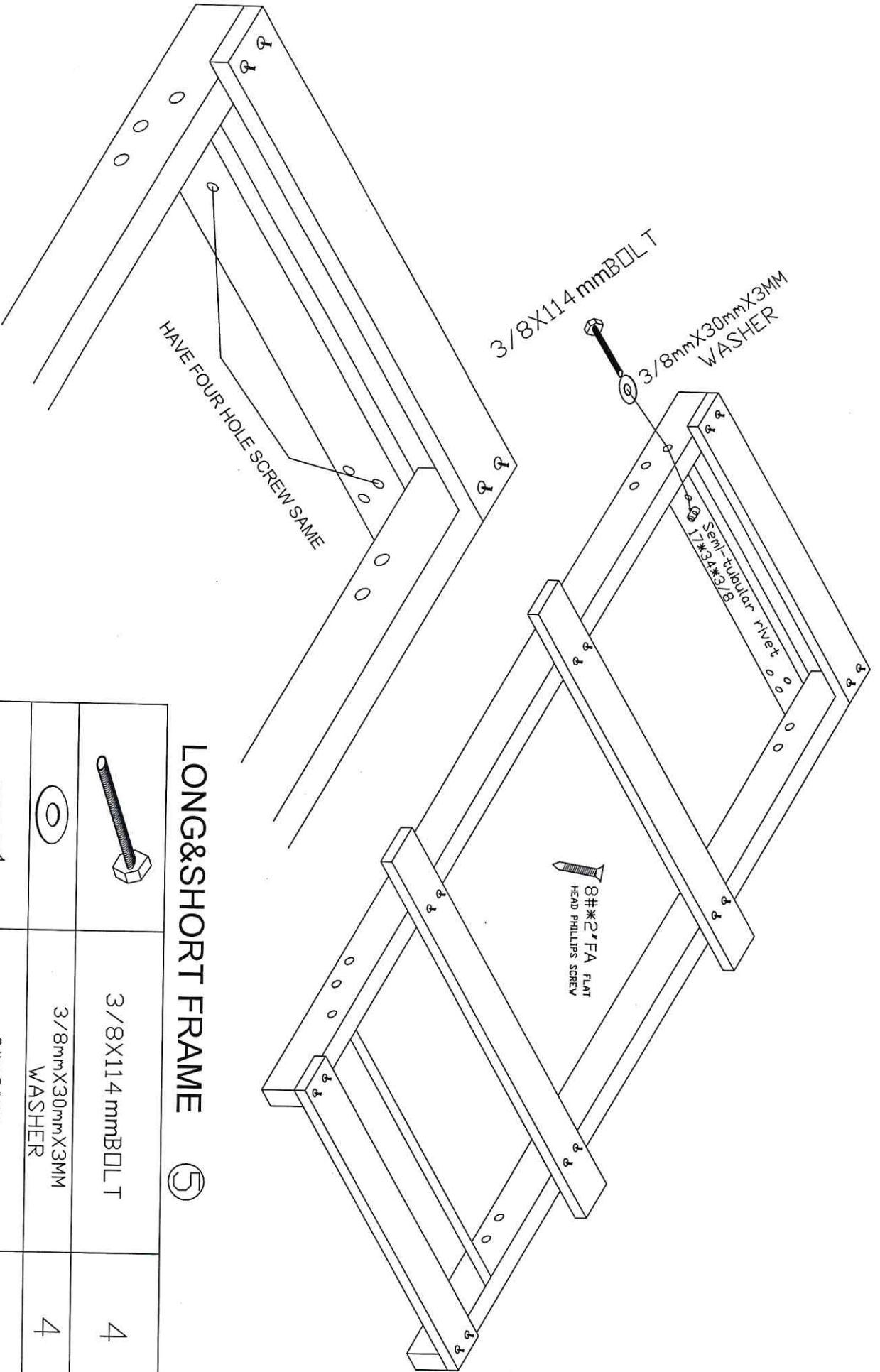

TABLE LEG ①





PART#	DESCRIPTION	QTY
	3/8X38mmBOLT	12
	3/8X76mmBOLT	16
	3/8mmx77mm NUT	16
	3/8mmx30mmx3mm WASHER	44



STEP 3



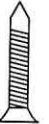

LONG&SHORT FRAME ⑤

	3/8X114 mm BOLT	4
	3/8mmX30mmX3MM WASHER	4
	8#*2" FA FLAT HEAD PHILLIPS SCREW	16
	Semi-tubular rivet 17*34*2/B	4

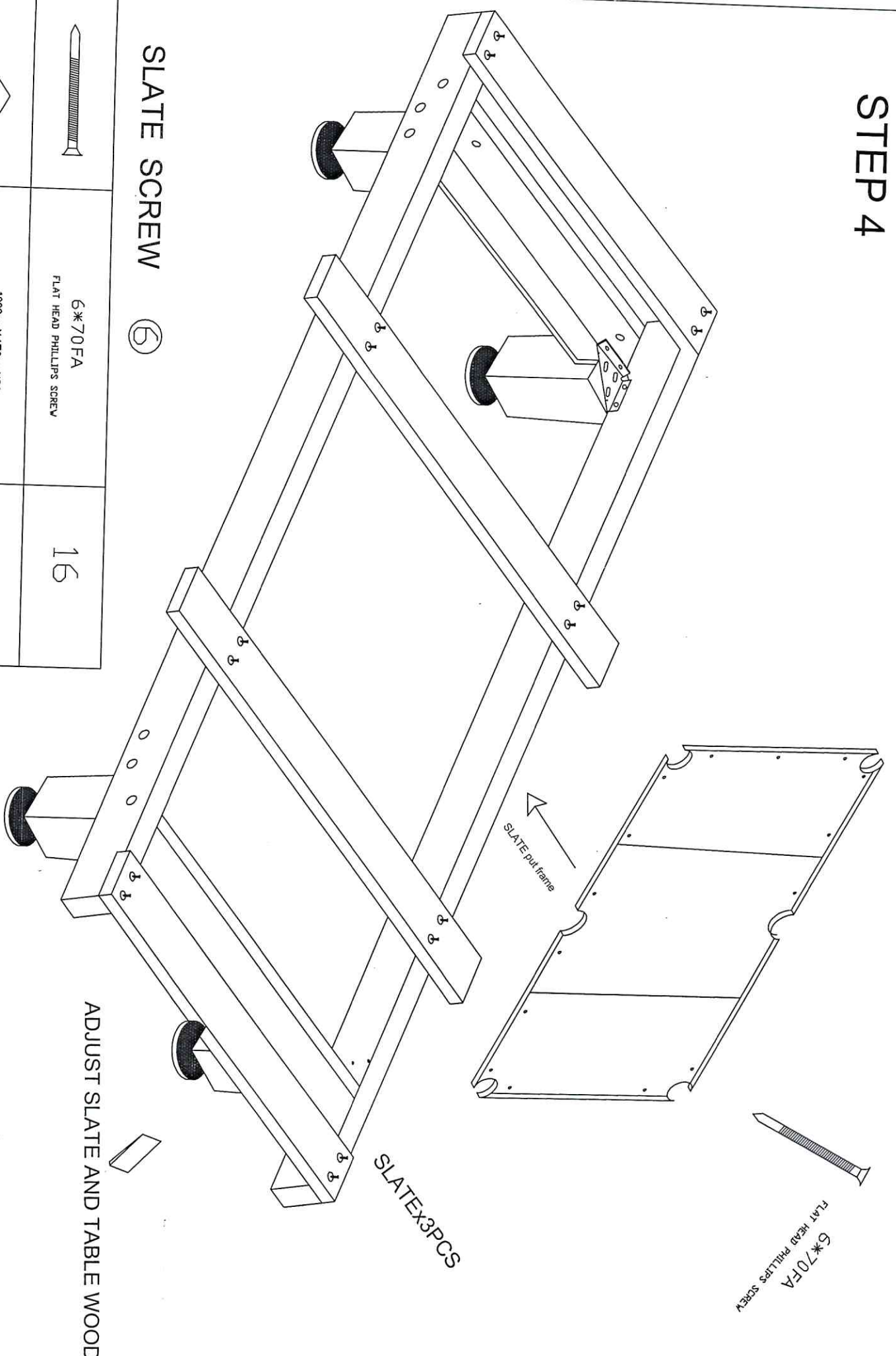
STEP 4

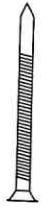

SLATE SCREW ⑥

	6*70FA FLAT HEAD PHILLIPS SCREW	16
	1000mmX450mmX80mm WOOD	16

6*70FA
FLAT HEAD PHILLIPS SCREW

SLATE X 3 PCS

ADJUST SLATE AND TABLE WOOD

STEP 5

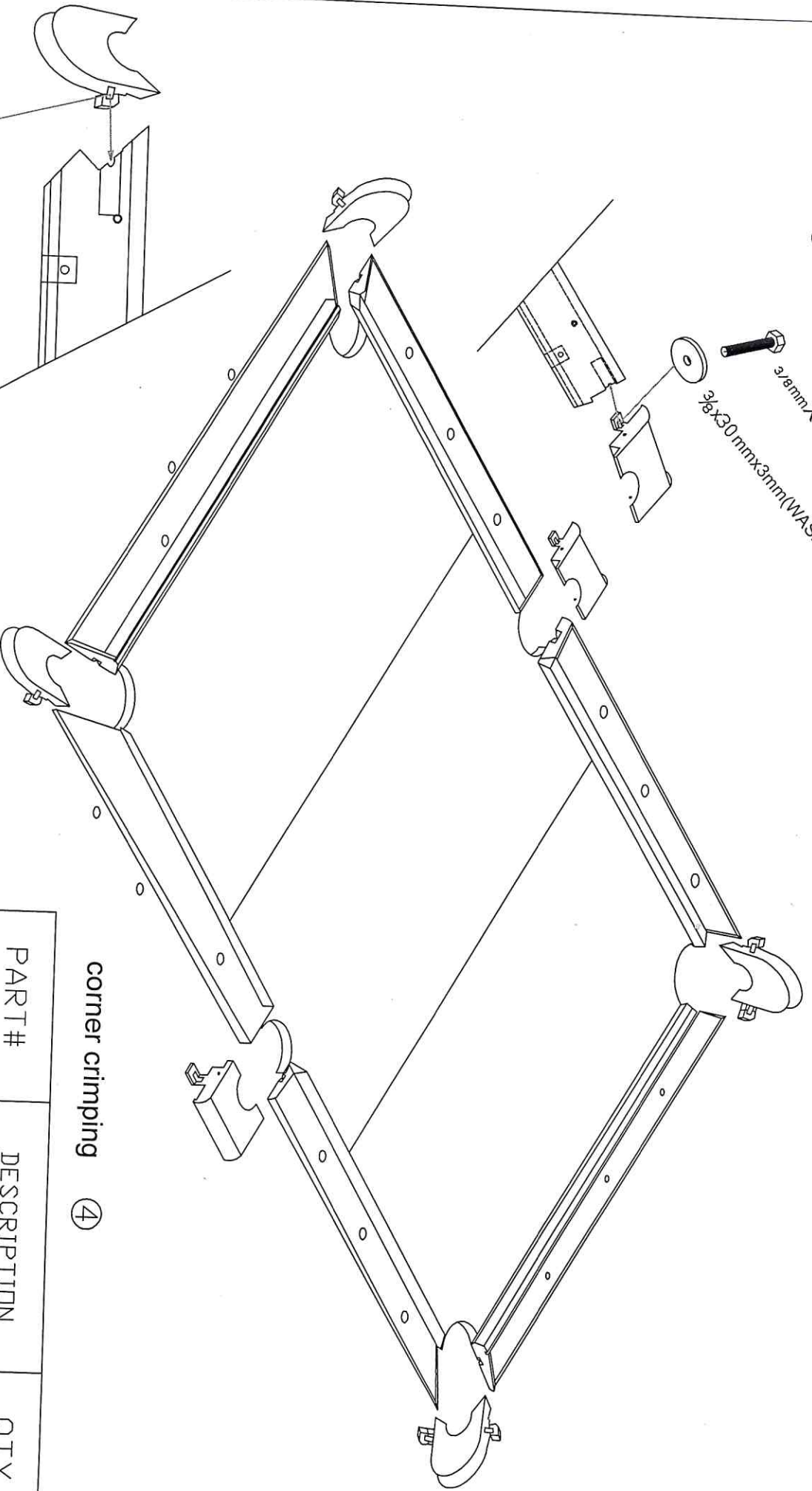

3/8mmX35 BOLT

3/8X30 mmX3mm(WASHER)

3/8mmX35BOLT
3/8X30 mmX3mm(WASHER)

6X16 mmBOLT



corner crimping ④

PART #	DESCRIPTION	QTY
	3/8X35 mmBOLT	12
	3/8mmX30mmX3MM WASHER	12
	6X16 mmBOLT	16

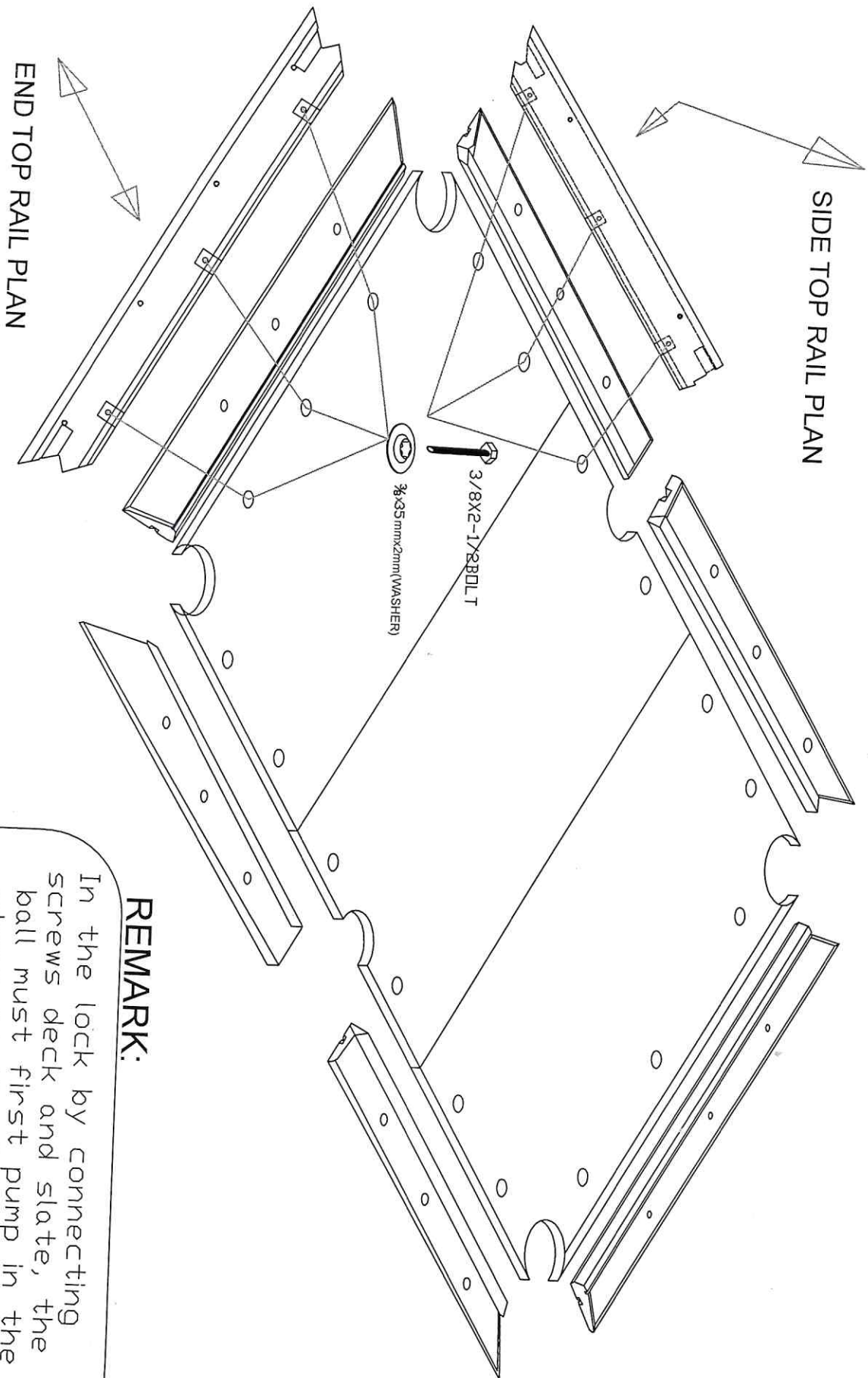
STEP 6



TOP RAIL ②

	3/8X63.5mmBOLT	18
	3/8X24mmX3mm WASHER	18

REMARK:

In the lock by connecting screws deck and slate, the ball must first pump in the stone on the tablecloth, and we rely on him to wrap cloth.

STEP 7

They are the two holes

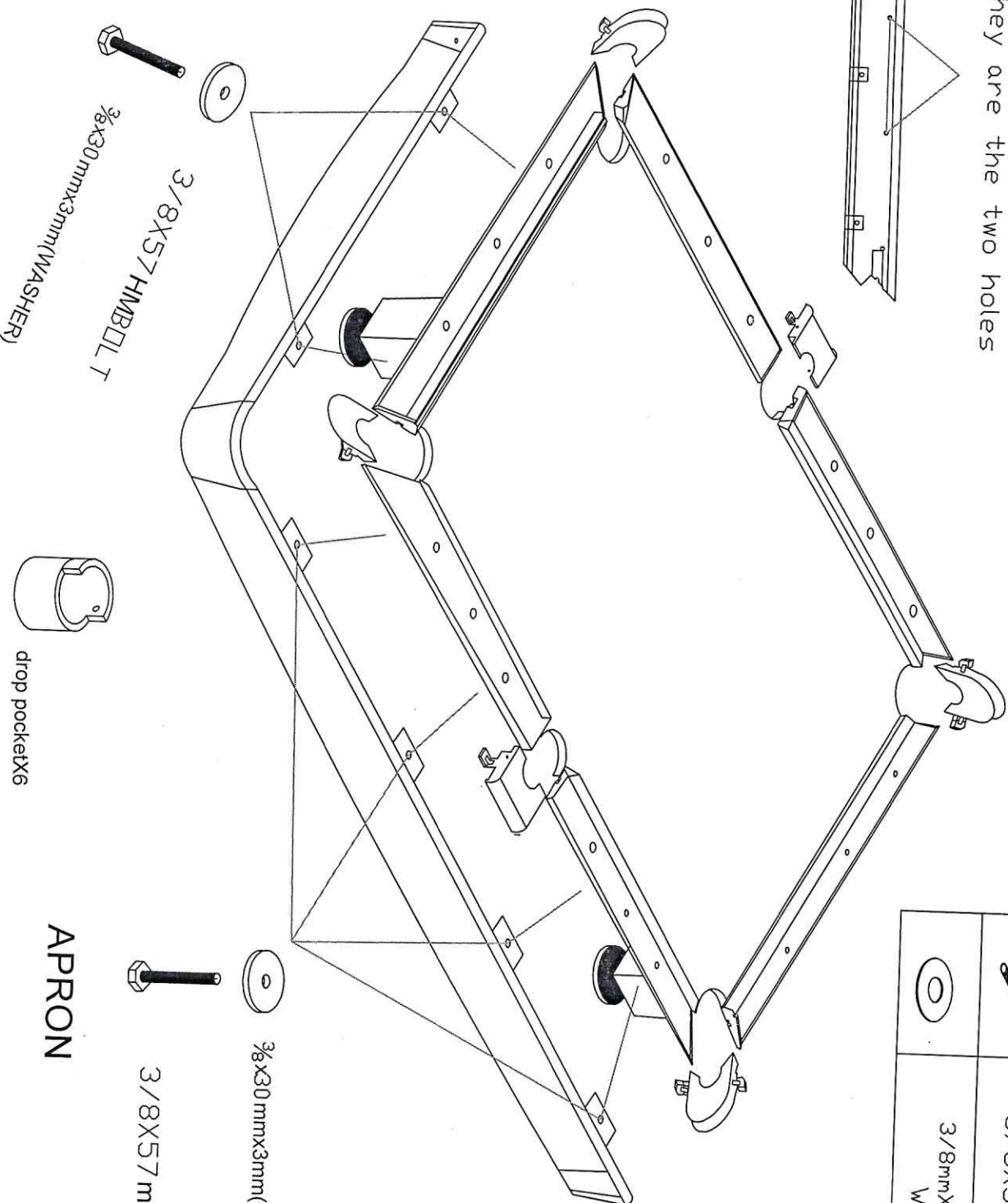
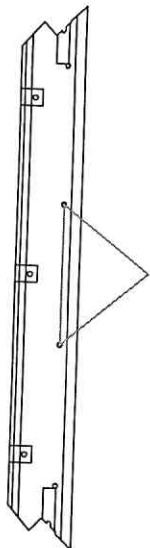

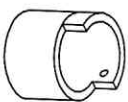

3/8x30mmx3mm(WASHER)
3/8x57mmHMBOLT



drop pocket install corner
drop pocketx6

3/8x30mmx3mm(WASHER)
3/8x57mmHMBOLT

APRON

APRON ③		
	3/8x57mm BOLT	12
	3/8mmx30mmx3mm WASHER	12